

HURRICANE BOAT LIFTS



A NEW MILLENNIUM OF **BOAT LIFTS**



YOU'VE MADE THE INVESTMENT, NOW

ENJOY THE WATER

New aerial of headquarters
Tracy - drone

New copy

Tracy Reo



CONTENTS

INTRODUCTION

Letter from the CEO/President	2
Which Lift is for You	4-5
Craftsmanship	6-7

BOAT LIFTS

CATEGORY 1 Small Craft Lift Systems	8-9
CATEGORY 1 PWC	10-11
CATEGORY 2 Beamless Lift Systems	12-13
Quality Control	14-15
CATEGORY 3 Elevator Lift Systems	16-17
Engineering	18-19
CATEGORY 4 Platform Lift Systems	20-23
CATEGORY 5 Cradle Lift Systems	24-25
CATEGORY Y Yacht Lift Systems	26-27
CATEGORY B Boat House Lift Systems	28-29
CATEGORY C Commercial Lift Systems	30-31
CATEGORY C Marina	32-33

BOAT LIFT FEATURES

Choosing Your Power	34
Customer Benefits	35

ACCESSORIES

Accessories	36-37
-------------	-------

DEALER NETWORK

Locations	38-39
-----------	-------



24,000 lb. 8 Pole Lift





WHICH LIFT IS FOR YOU?

We manufacture a wide variety of lifts. Whether you are on a lake, canal, intracoastal, shallow or deep water, we have a lift that will suit your needs. At Hurricane Boat Lifts we create a boating experience that is easy and hassle-free. Choose from 8 different categories of lifts.

If you are in need of a custom lift, feel free to contact us and we will design a lift just for you.

New pic - remove old flat plate and D26 gears



Small Craft Lift Systems page 8

CATEGORY



Beamless Lift Systems page 12

CATEGORY

New pic - remove old flat plate and D26 gears



Elevator Lift Systems page 16

CATEGORY



Platform Lift Systems page 20

CATEGORY

New pic - remove old flat plate and D26 gears



Cradle Lift Systems page 24

CATEGORY



Yacht Lift Systems page 26

CATEGORY

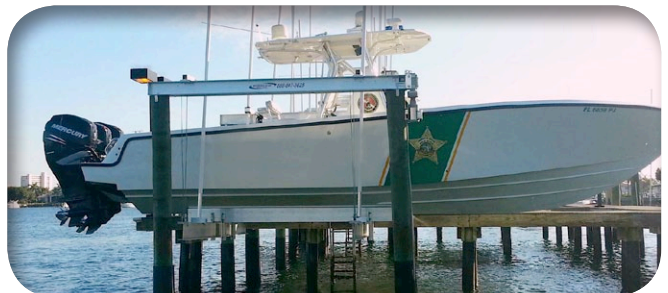

Boathouse Lift Systems page 28

CATEGORY



Commercial Lift Systems page 30

CATEGORY

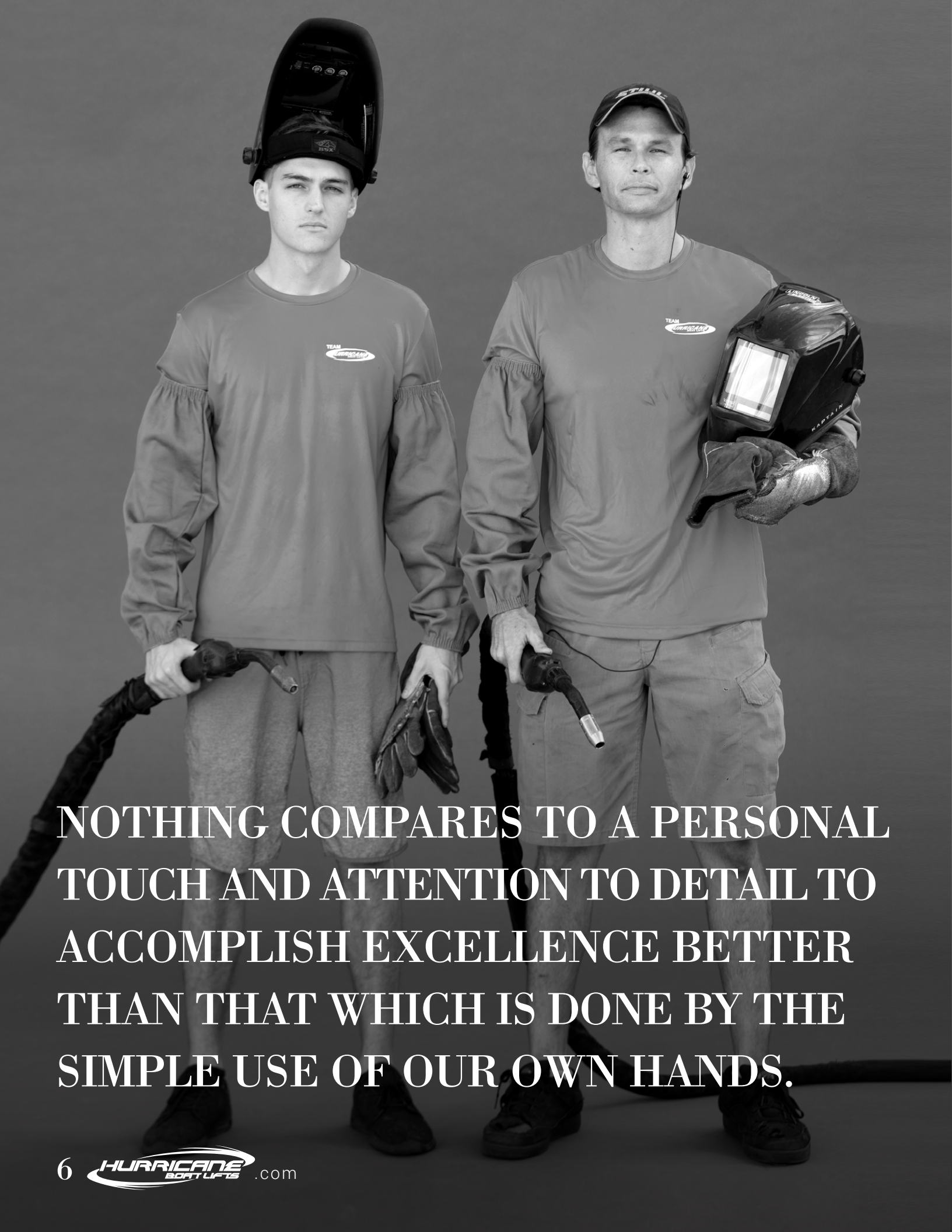

NOTHING COMPARES TO A PERSONAL TOUCH AND ATTENTION TO DETAIL TO ACCOMPLISH EXCELLENCE BETTER THAN THAT WHICH IS DONE BY THE SIMPLE USE OF OUR OWN HANDS.



Only a **SELECT** few make it to become a Hurricane Boat Lift welder. All of our welders are trained and **CERTIFIED** to exceed the welding requirements of the American Welders Society. Many admire the **QUALITY** and **PERFECTION** of our precision



welds. We invite you to see for yourself the **EXCELLENCE** of a **HURRICANE** Lift.



CATEGORY

SMALL CRAFT LIFT SYSTEMS

2,500 lb. Lift

We challenge you to find a better single pole Personal Watercraft (PWC) lift. We use only top grade marine aluminum throughout with Nylatron rollers that provide smooth operation.

STANDARD FEATURES:

- 6061-T6 Aluminum
- Zinc Anodes
- Nylatron Rollers
- Stainless Steel Cables
- Half Wrapped Carpeted Bunks
- Momentary Switch
- Guide Poles
- Universal mount for Seawall, Dock or Piling

See page 36 for accessories

WARRANTY:

- 12 Year Structural
- 5 Year Gear Box
- 2 Year Motor
- 2 Year Comprehensive

See warranty for complete details

CAPACITIES:

1,500 lbs.
2,500 lbs.



2,500 lb. Lift

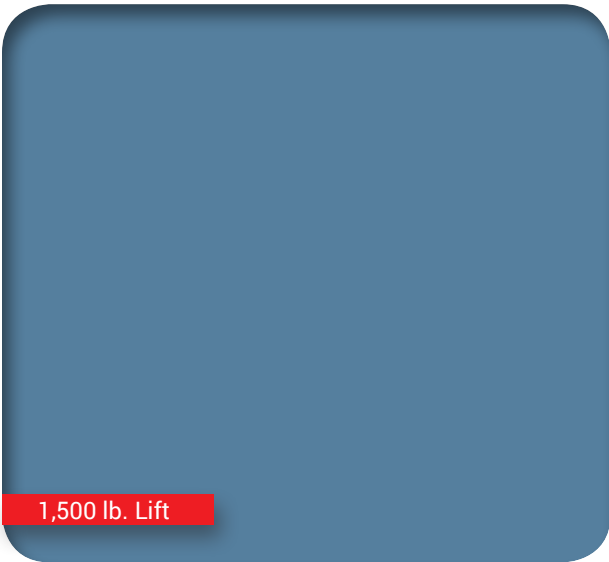

1,500 lb. Lift



New pic

2,500 lb. Lift



2,500 lb. Lift



PWC LIFT SYSTEMS

CATEGORY



3,000 lb. Dual PWC Lift

We challenge you to find a better single pole Personal Watercraft (PWC) lift. We use only top grade marine aluminum throughout with Nylatron rollers that provide smooth operation.

STANDARD FEATURES:

- 6061-T6 Aluminum
- Zinc Anodes
- Nylatron Rollers
- Stainless Steel Cables
- Half Wrapped Carpeted Bunks
- Momentary Switch
- Guide Poles
- Universal mount for Seawall, Dock or Piling

See page 36 for accessories

WARRANTY:

- 12 Year Structural
- 5 Year Gear Box
- 2 Year Motor
- 2 Year Comprehensive

See warranty for complete details

CAPACITIES:

- 3,000 lbs.
- 7,000 lbs.
- 10,000 lbs.



7,000 lb. Triple PWC Lift



7,000 lb. Triple PWC Lift



2,500 lb. Lift

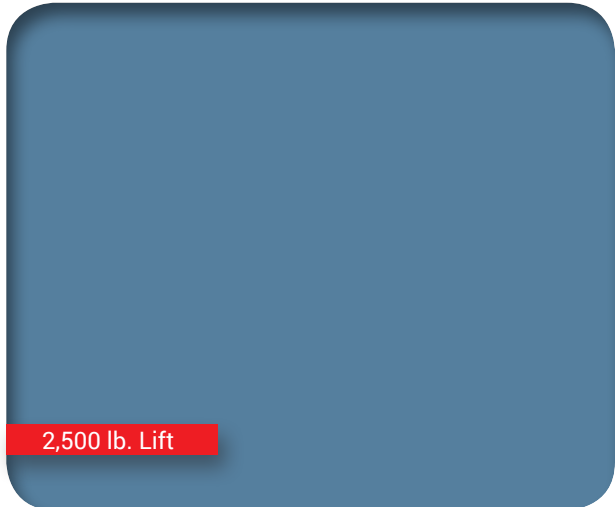

2,500 lb. Lift



CATEGORY

BEAMLESS LIFT SYSTEMS



10,000 lb. Lift

Our beamless lifts allow you easy access to your boat without worrying about a top beam in your way. This four-motor lift is quiet, smooth and extremely fast, helping you get on and off the water quicker.

STANDARD FEATURES:

- Built-in Adjustable Cable Keeper
- Smoked Plexi Cable Shield
- 6061-T6 Aluminum
- Stainless Steel Cables
- Standard Remote Control
- Nylatron Bearings
- Aluminum Bunks, Wood Bunks on 24k and 30k
- Stainless Steel Motors

See page 36 for accessories

WARRANTY:

- 15 Year Structural
- 5 Year Gear Box
- 2 Year Motor
- 2 Year Comprehensive

See warranty for complete details

CAPACITIES:

- 10,000 lbs.
- 13,000 lbs.
- 16,000 lbs.
- 20,000 lbs.
- 24,000 lbs.
- 30,000 lbs.

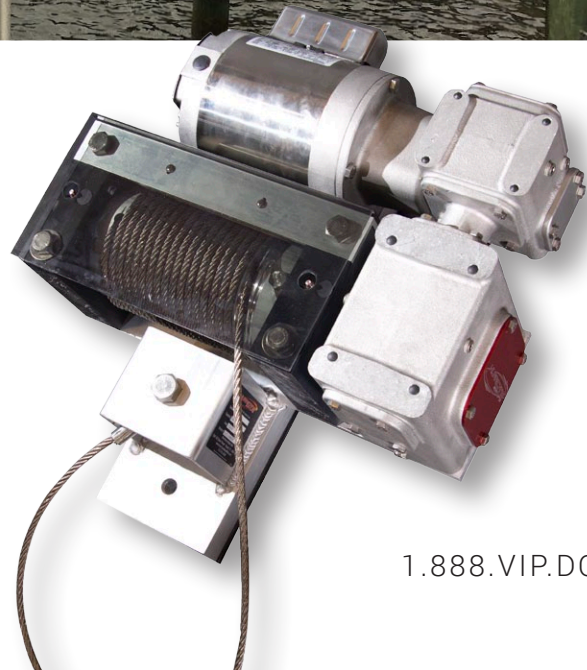



**HURRICANE MACHINISTS’
CRAFTSMANSHIP AND ATTENTION
TO DETAIL GIVE YOU NOTHING LESS
THAN A MASTERPIECE. WELCOME TO
THE EXCELLENCE OF HURRICANE
BOAT LIFTS.**



Hurricane Boat Lifts brings you the **FUTURE** of boat lifts today. We **MANUFACTURE** every aluminum part that we put into our lifts. One look at a Hurricane Boat Lift and you will see the **QUALITY**, **PRECISION** and **PRIDE** put into every lift we build.





ELEVATOR LIFT SYSTEMS

CATEGORY



For those who demand the very best in an elevator lift, we use Nylatron cupped wheels and stainless steel wheel brackets on all of our elevator lifts. We are the only manufacturer with adjustable cable keepers standard on all of our elevator lifts. We are the number one manufacturer of elevator lifts in Florida, if not throughout the world.

STANDARD FEATURES:

- Elite Head Unit with Adjustable Cable Keepers
- Oversized Grooved Winders
- Half Wrapped Carpeted Bunks
- Stainless Steel Brackets
- Cupped Nylatron Wheels
- Maintain Switches
- Universal Mount for Dock or Seawall
- Stainless Steel Cables
- Rubber Bolt Caps

WARRANTY:

- 12 Year Structural
- 5 Year Gear Box
- 2 Year Motor
- 2 Year Comprehensive

See warranty for complete details

CAPACITIES:

- 3,000 lbs.
- 7,000 lbs.
- 10,000 lbs.
- 12,000 lbs.
- 15,000 lbs.
- 17,000 lbs.
- 20,000 lbs.
- 24,000 lbs.
- 27,000 lbs.
- 30,000 lbs.
- 33,000 lbs.
- 40,000 lbs.



20,000 lb. High Speed Lift with Deck



15,000 lb. Reverse Gussett Lift



15,000 lb. Lift



24,000 lb. Lift



20,000 lb. Lift



10,000 lb. 10° Lift



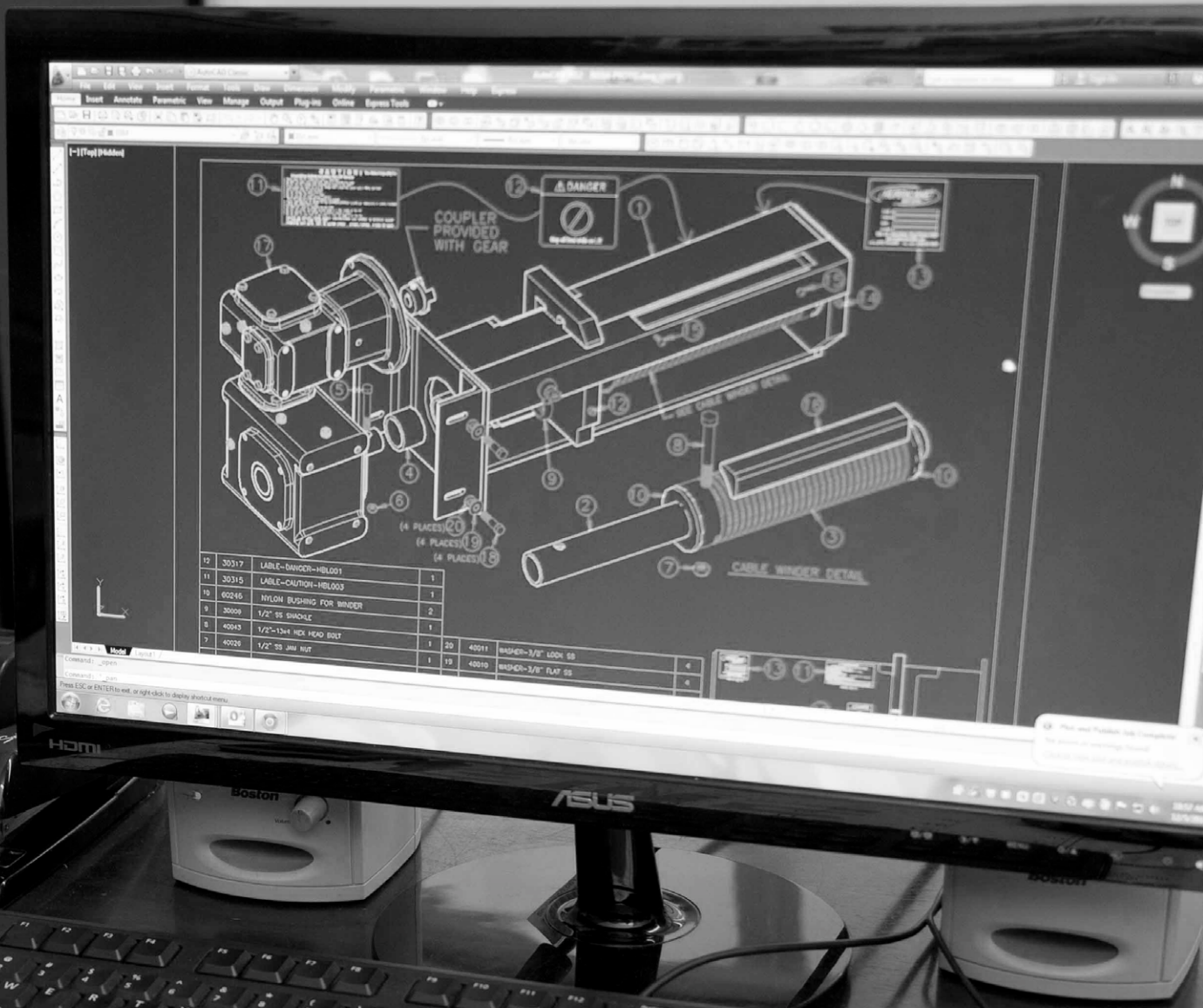

ENGINEERING SECOND TO NONE.
PRECISE CAD PRODUCED CERTIFIED
DRAWINGS AND SPECIFICATIONS,
NOW WHO ARE YOU GOING TO TRUST
WITH YOUR BABY?

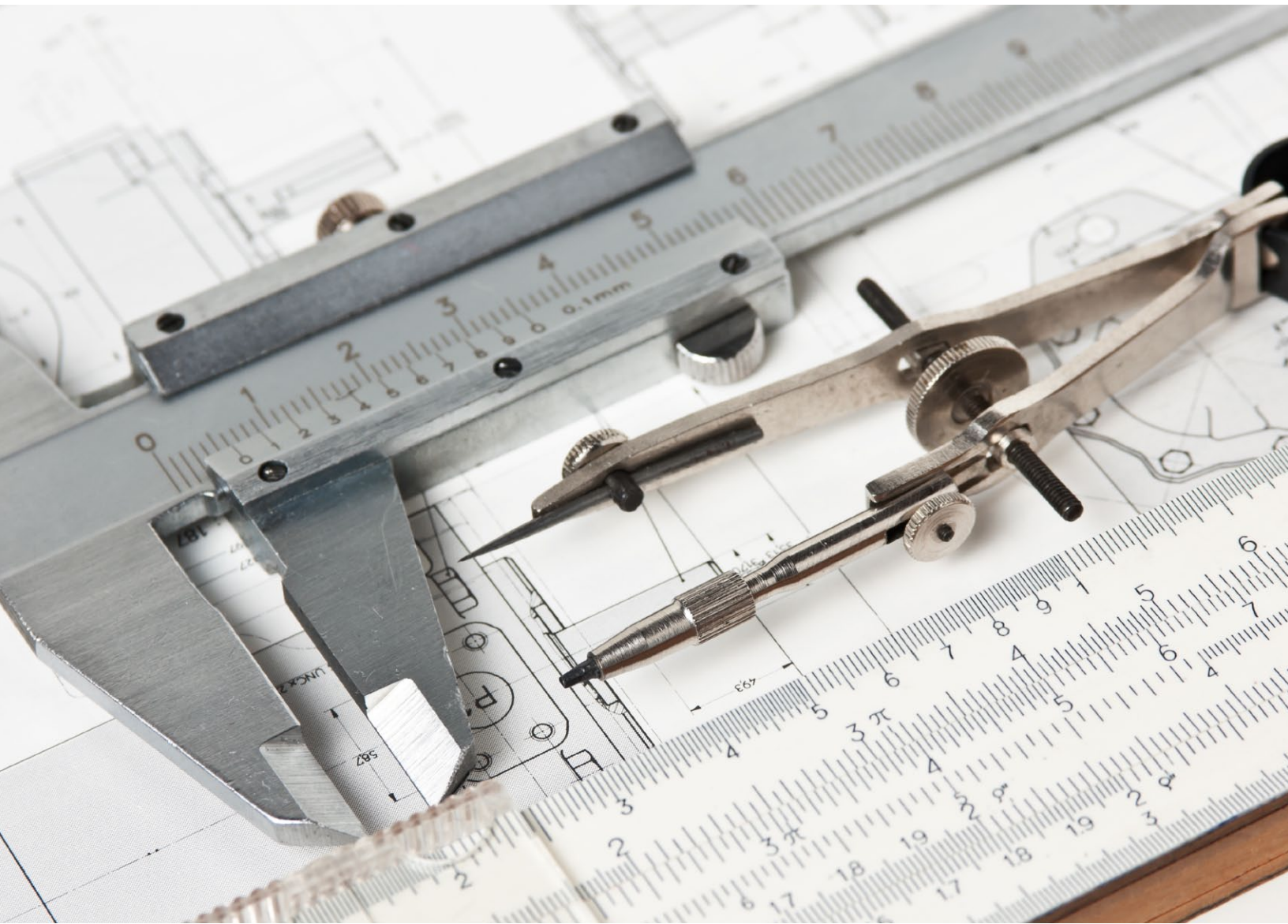

Simply put, a Hurricane Boat Lift is **SUPERIOR** to the competition. Our engineers and designers do not sleep at night, so you can. They lie awake **THINKING** of new ideas and **INNOVATIONS** such as our patented Lift Lock™ and our patent-pending Lift Alert to give you **PEACE** of mind.



CATEGORY

PLATFORM LIFT SYSTEMS



16,000 lb. Lift

Walk around your boat with ease. The all new platform lift is custom built to your specifications. The entire deck drops into the water with ease. This is the “ultimate lift of lifts” with auto leveling deck. Unobstructed access to your boat allows for ease of loading and unloading of gear after a great day on the water.

STANDARD FEATURES:

- Auto Leveling Deck
- Auto Stop Remote Control
- Flow Through Decking
- Direct Drive Gear
- Locking Deck
- 6061-T6 Aluminum
- All Stainless Components

See page 36 for accessories

WARRANTY:

- 10 Year Structural
- 5 Year Gear Box
- 2 Year Motor
- 2 Year Comprehensive

See warranty for complete details

CAPACITIES:

- 7,000 lbs.
- 16,000 lbs.
- 24,000 lbs.
- Custom lbs.



7,000/10,000 lb. Lift



Removable Rear Access Platform



24,000 lb. Lift



7,000 lb. Lift



24,000 lb. Lift





THIS IS WHY WE
BLOW AWAY THE COMPETITION!





CRADLE LIFT SYSTEMS

CATEGORY



24,000 lb. Lift

Hurricane's Cradle Lift is our most popular lift, with aluminum grooved winders, aluminum pulleys and stainless steel pile mount brackets, all standard. The cradle lift is available with any option you could ever dream of. With its slick design, there are no unsightly bearings and drive shafts exposed, providing a clean look on your dock.

STANDARD FEATURES:

- Aluminum Grooved Winders
- Half Wrapped Carpeted Bunks
- Rubber Bolt Caps
- Stainless Pile Mount Brackets
- 6061-T6 Aluminum
- Aluminum Pulleys
- Stainless Steel Cables
- Maintain Switches

See page 36 for accessories

WARRANTY:

- 15 Year Structural
- 5 Year Gear Box
- 2 Year Motor
- 2 Year Comprehensive

See warranty for complete details

CAPACITIES:

- 4,500 lbs.
- 7,000 lbs.
- 10,000 lbs.
- 13,000 lbs.
- 16,000 lbs.
- 20,000 lbs.
- 24,000 lbs.



10,000 lb. Solar Lift



13,000 lb. Lift



16,000 lb. Lift



10,000 lb. Lift



13,000 lb. Lift



YACHT LIFT SYSTEMS

CATEGORY



50,000 lb. Lift

Have a yacht? No problem for Hurricane Boat Lifts. With its sleek design you will be proud to show off your lift and your yacht.

STANDARD FEATURES:

- 6061-T6 Aluminum
- Large Grooved Winders
- Stainless Cables
- Cable Keepers
- Rubber Bolt Caps
- Stainless Pile Mount Brackets
- Standard Remote Control

See page 36 for accessories

WARRANTY:

- 15 Year Structural
- 5 Year Gear Box
- 2 Year Motor
- 2 Year Comprehensive

See warranty for complete details

CAPACITIES:

- 24,000 lbs.
- 32,000 lbs.
- 40,000 lbs.
- 50,000 lbs.
- 60,000 lbs.
- 80,000 lbs.
- 100,000 lbs.



32,000 lb. 6-Pole Lift



24,000 lb. 8-Pole Lift with Custom Cradles



40,000 lb. Lift

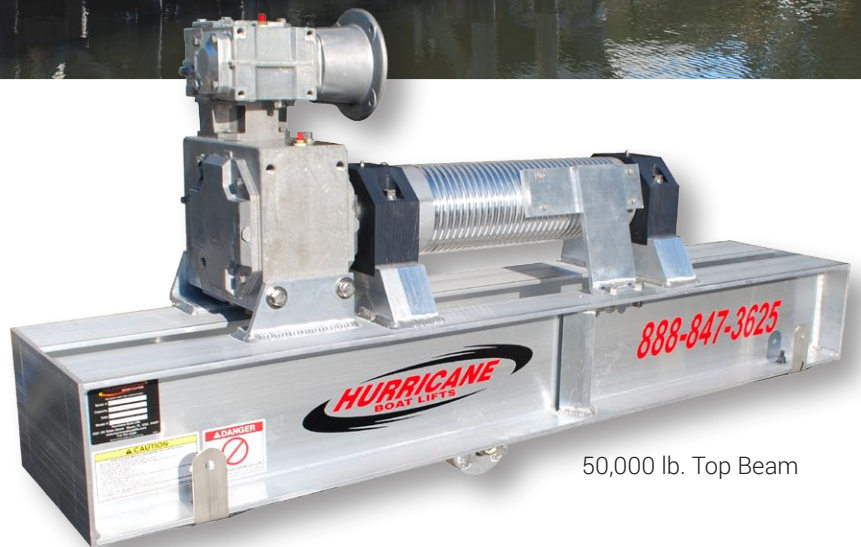

50,000 lb. Top Beam



New pic - New gears

8,000 lb. Lift

Have a boat house? We have three boat house lifts for you to choose from. Our boat house lift is smooth, adjustable and quiet.

STANDARD FEATURES:

- 6061-T6 Aluminum Construction
 - Full Adjustable Design
 - Slide on Pulley Brackets and Deadman Brackets
 - Rubber Bolt Caps
 - Aluminum Pulleys
 - Maintain Switches
- See page 36 for accessories*

WARRANTY:

- 15 Year Structural
 - 5 Year Gear Box
 - 2 Year Motor
 - 2 Year Comprehensive
- See warranty for complete details*

CAPACITIES:

- 3,000 lbs.
- 6,000 lbs.
- 8,000 lbs.

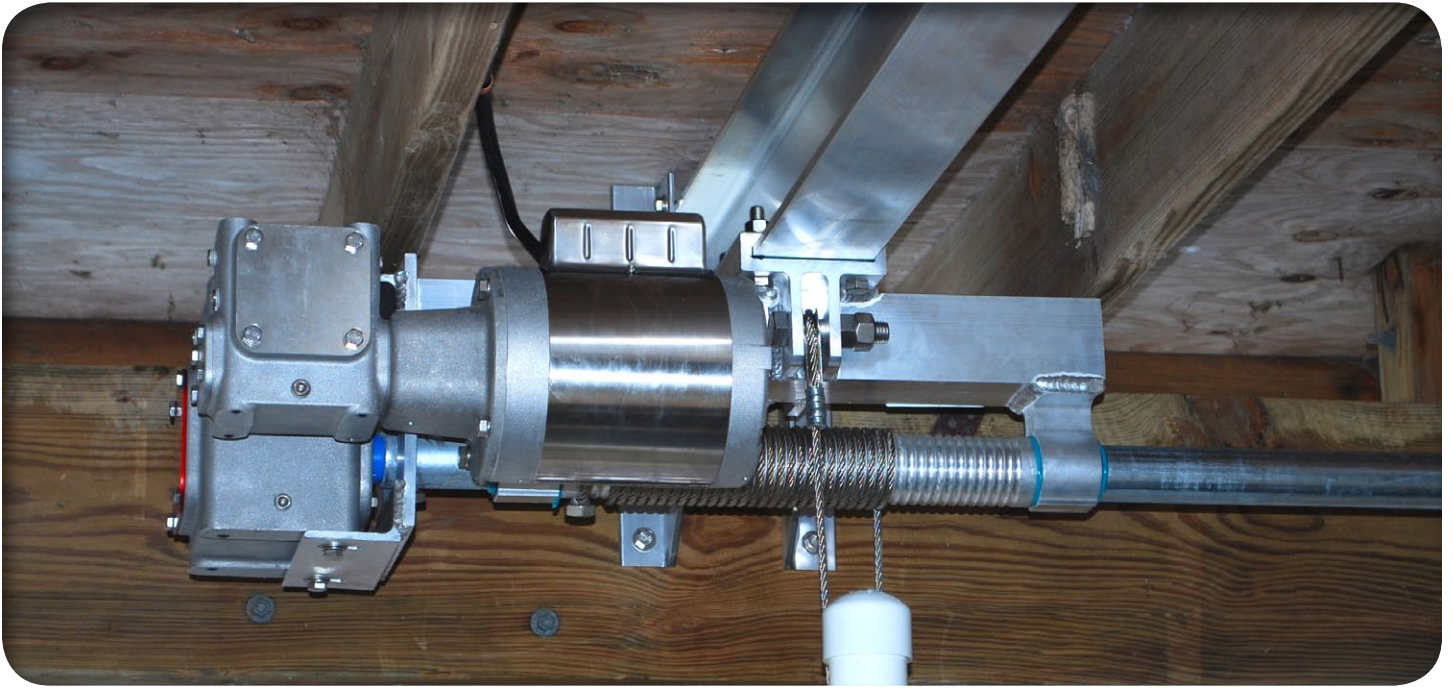

10,000 lb. Lift with Brackets

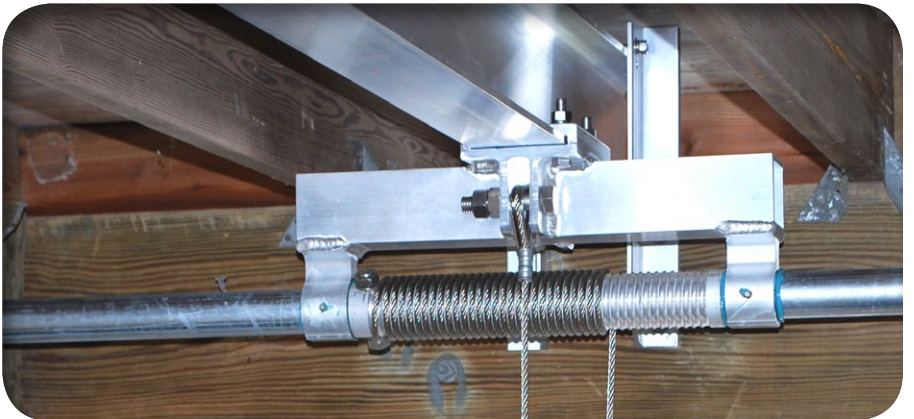



COMMERCIAL LIFT SYSTEMS

CATEGORY



16,000 lb. Lift

Hurricane's commercial lift is perfect for law enforcement and government applications.

STANDARD FEATURES:

- 6061-T6 Aluminum
- Aluminum Bunks
- Heavy Duty Guide Brackets
- Top Beam Guide Brackets
- Ultra High Speed Gear
- Rubber Bolt Caps
- Autostop Remote Control
- Deep Grooved Winders with Cable Keepers
- Stainless Steel Cables
- Aluminum Pulleys

See page 36 for accessories

WARRANTY:

- 5 Year Structural
- 2 Year Gear Box
- 2 Year Motor
- 2 Year Comprehensive

See warranty for complete details

CAPACITIES:

- 4,500 lbs.
- 7,000 lbs.
- 10,000 lbs.
- 13,000 lbs.
- 16,000 lbs.
- 20,000 lbs.
- 24,000 lbs.



24,000 lb. Lift



16,000 lb. Lift



24,000 lb. Lift



Law Enforcement Marina



COMMERCIAL MARINA LIFT SYSTEMS

CATEGORY



24,000 lb. Lifts

Hurricane's commercial lift is perfect for Marina applications.

STANDARD FEATURES:

- 6061-T6 Aluminum
- Aluminum Bunks
- Heavy Duty Guide Brackets
- Top Beam Guide Brackets
- Ultra High Speed Gear
- Rubber Bolt Caps
- Autostop Remote Control
- Deep Grooved Winders with Cable Keepers
- Stainless Steel Cables
- Aluminum Pulleys

See page 36 for accessories

WARRANTY:

- 5 Year Structural
- 2 Year Gear Box
- 2 Year Motor
- 2 Year Comprehensive

See warranty for complete details

CAPACITIES:

- 4,500 lbs.
- 7,000 lbs.
- 10,000 lbs.
- 13,000 lbs.
- 16,000 lbs.
- 20,000 lbs.
- 24,000 lbs.



24,000 lb. Lifts



16,000 lb. Lift



24,000 lb. Lift



Law Enforcement Marina

EVERYTHING YOU NEED TO KNOW ABOUT

CHOOSING YOUR GEAR

We have the gear drive for you: from the 50 year industry standard flat plate gear drive to the unsurpassed speed of the Hurricane "UHS" Ultra High Speed Gear. With all our available options, why look anywhere else?

New pic - old gear
AMS 450 Gear
D500 Gear
need to shoot



Marine Flat Plate Drive

This flat plate is available for lifts up to 16,000 lbs. The flat plate has been around for over fifty years. Available in galvanized or stainless steel, this flat plate has stood the test of time and delivers quality and cost effective lifting power. Comes with a warranty up to 25 years.*

ASM EBD Drive

This gear is an enclosed belt drive system that is double the speed of the flat plate gear. The gear features a double sealed output shaft, rigid cast aluminum case and has speeds up to 47" per minute. Available on lifts up to 13,000 pounds. Comes with a 5 year warranty.*

Hurricane Direct

This is our most popular gear with safe, quiet operation. This gear has been reliable and is aesthetically pleasing. This gear contains both a bronze worm gear and a bronze main gear providing years of safe operation. Comes with a 5 year warranty.*

Hurricane UHS

This Ultra High Speed (UHS) gear comes in a sleek design. The UHS gear is fast, quiet, maintenance free and will provide you years of trouble free service. The UHS gear is available in speeds up to 80" per minute depending on the weight of the vessel. Comes with a 5 year warranty.*

AT HURRICANE BOAT LIFTS,
WE PROMISE TO BE THERE FOR YOU
BEFORE AND AFTER THE STORM



Truck load ready for delivery



Daily Deliveries



Overseas Shipping

Hurricane Boat Lifts attends most international boat shows and our dealers attend their local boat shows. We deliver lifts along the entire East Coast and we ship worldwide. Contact Hurricane Boat Lifts Corporate Headquarters for any questions you may have about shipping.



ACCESSORIES

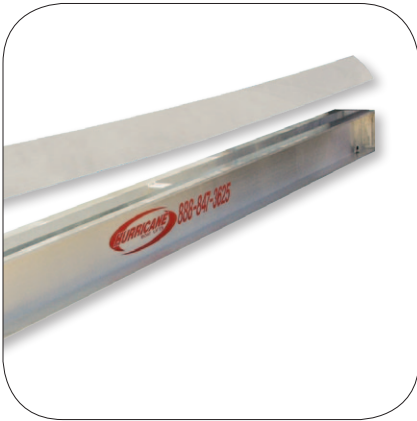

Top Beam Covers



Elevator Lift Lock™ Kit

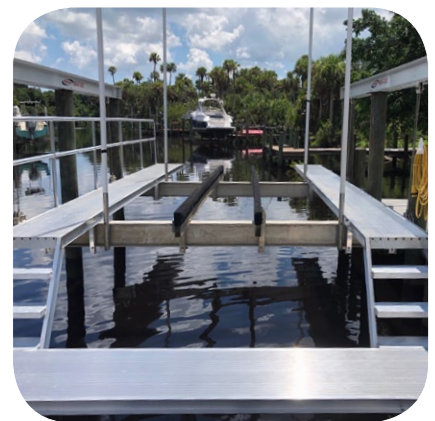

**Side Walkboards with Step Down
Double Wide Rear Platform**



LED Light Kit



Double Wide Loading Platform



Fold Down Loading Platform



Adjustable Walkboard Step
Available in 2,3,4 & 5-step
configurations



Welded Walkboards
Available in lengths up to 24'



Extruded Walkboards
Available in lengths up to 30'



Pull Up Ladders

Available in 2,3,4, 5 & 7-step configurations

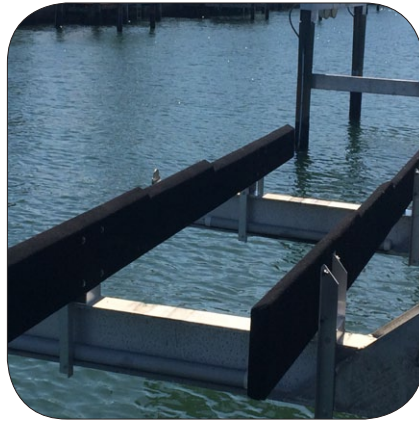

Custom Stepped Bunks



Sailboat Stantions

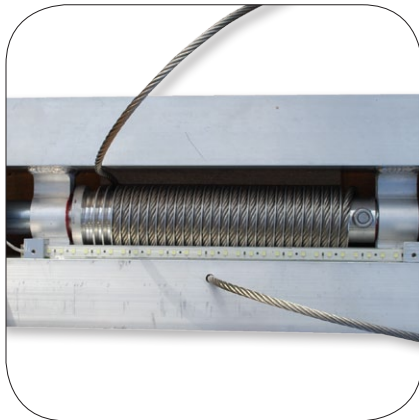

Deep Groove Winders



Standard Remote Control



Boat House Side Pile Mount Bracket

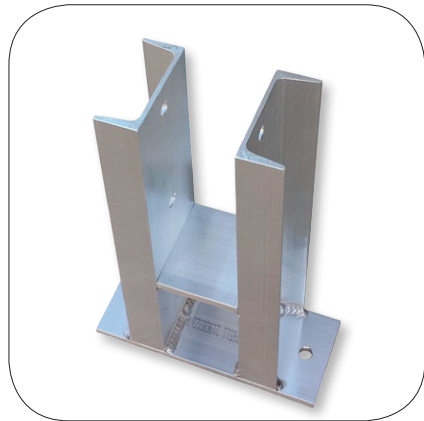

Boat House Support Bracket



Sail Boat Cradles

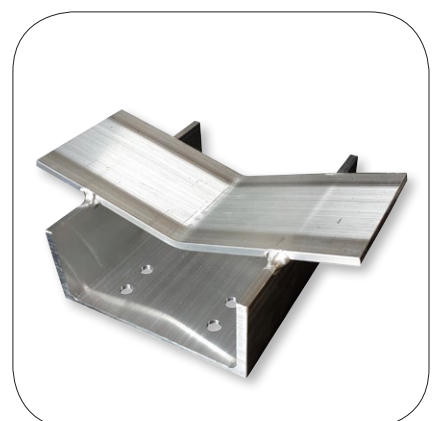

Pontoon Bunk Bracket

YOU'VE MADE THE INVESTMENT,
NOW TAKE ADVANTAGE OF OUR
DEALER NETWORK

Hurricane Boat Lifts has an international network of dealers worldwide. Contact us for a list of Hurricane Authorized Contractors in your area. We also have Hurricane Boat Lifts and Dock Supply stores to serve all your lift and dock needs with stores in Stuart, Florida, Islamorada, Florida, Cape Cateret/Swansboro, North Carolina and openings coming in 2015 to Middletown, New Jersey, The Lower Keys of Florida and the coast of Texas. We have every accessory ever made for docks.

Are you a Marine Contractor who would like to become a dealer?

Contact our corporate headquarters in Stuart, Florida, as areas are filling up fast.

Interested in becoming a store owner?

Call us to see the benefits of owning your own Hurricane Boat Lifts and Dock Supply.



Islamorada, Florida



Stuart, Florida

Hurricane Boat Lifts is opening Boat Lift and Dock Supply stores across the Nation. Just some of the products we carry:

- Hurricane Boat Lifts
 - xDocks Floating Dock and Drive on Systems
 - Cubic Dock Floating Dock and Drive on Systems
 - Wave Armor Floating Dock and Drive on Systems
 - Shurhold Boat Cleaning Products
 - Marina Dock Products
 - Engle/Hurricane Coolers
 - International Dock Products
 - Fish Cleaning Tables
 - Dock Boxes
 - Dock Lighting
 - Power Pedestals
 - Wash Down Products
 - Cleats, Hose Holders
 - Slidemoor Products
 - Bumpers
 - Davits
- Too much to list!

Interested in owning your own Hurricane Boat Lift and Dock Supply store? Contact corporate headquarters to see all the benefits of owning your own store.

Hurricane Boat Lifts and Dock Supplies coming soon to:

Cape Cateret/Swansboro, North Carolina - February 2015

Middletown, New Jersey - June 2015

Coast of Texas - September 2015

The Lower Keys - Fall 2015



** In Florida and The Carribean only*

YOU'VE MADE THE INVESTMENT, NOW
ENJOY THE WATER



CORPORATE HEADQUARTERS

3301 S.E. Slater Street
Stuart, Florida 34997
Phone: 772.781.2556
Toll Free: 888.847.3625
Fax: 772.781.4854
www.hurricaneboatlifts.com

YOUR LOCAL DEALER: